



# Optimizing Efficiency and Regulatory Compliance

## E+PLC Range

Advanced control, data management and visualization, combined with the flexibility of a PLC



[eurotherm.co.uk/eplc](http://eurotherm.co.uk/eplc)

Life Is 

**Eurotherm**  
by Schneider Electric

# A Cost Effective Combination

Controlling a process more precisely can reduce energy usage, shorten processing times, minimize waste, and improve final product quality, all of which can increase your overall profitability.

The E+PLC range combines Eurotherm core expertise in measurement accuracy, precision control and tamper resistant recording, together with proven PLC functionality. The range includes a single box solution for small machine applications, and a modular platform solution for larger machine processes.

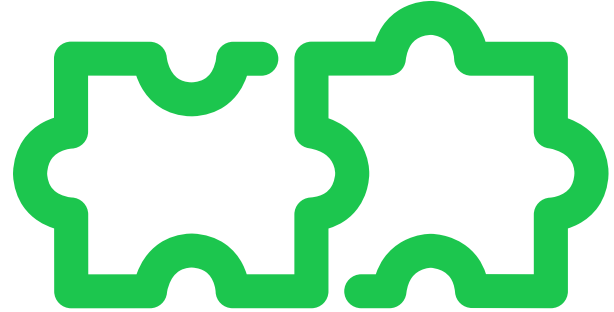

“

*“Eurotherm PID control in a PLC with recording – it’s game changing!”*

OEM engineer

## E

**Eurotherm** function block libraries

## +PLC

An integrated IEC 61131-3  
**PLC** environment

Sequential Function Chart

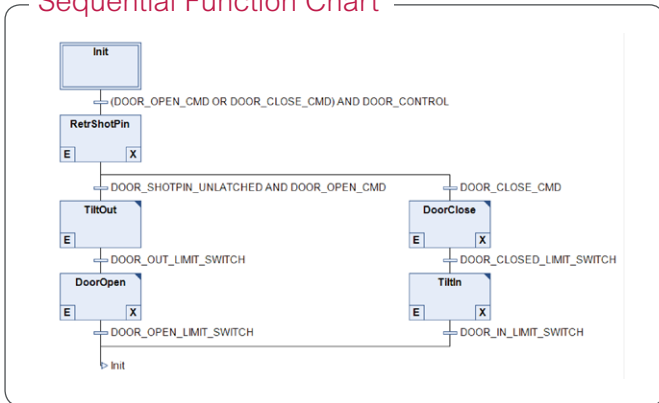

Ladder Diagram

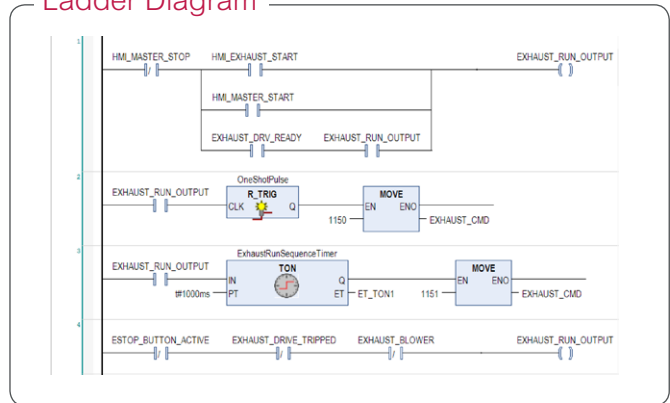

Structured Text

```

1 IF Purge_Complete THEN
2   IF Zone1_Combustion_Blower_MCP OR Zone1_Combustion_Blower_Disc THEN
3     Zone1_Burner_Start_Output := FALSE;
4     Zone1_HMI_Burner_Start := FALSE;
5     Zone1_Burner_Stop := TRUE;
6   END_IF
7
8   IF Zone2_Combustion_Blower_MCP OR Zone2_Combustion_Blower_Disc THEN
9     Zone2_Burner_Start_Output := FALSE;
10    Zone2_HMI_Burner_Start := FALSE;
11    Zone2_Burner_Stop := TRUE;
12  END_IF
13
14 IF Zone3_Combustion_Blower_MCP OR Zone3_Combustion_Blower_Disc THEN [3 lines]
15 END_IF
16
17 IF Zone4_Combustion_Blower_MCP OR Zone4_Combustion_Blower_Disc THEN [3 lines]
18 END_IF
19
20
21
22

```

Continuous Function Chart

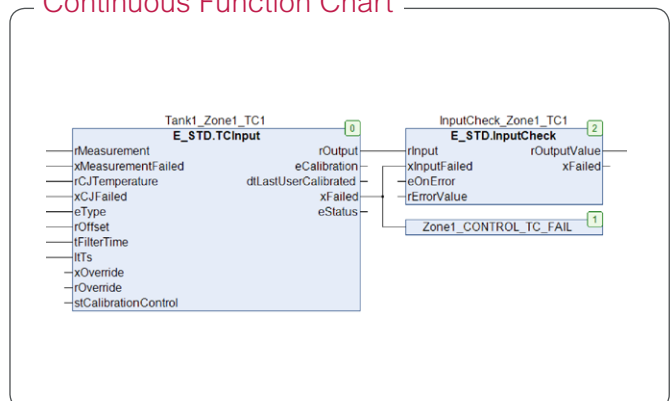

# Optimizing Efficiency and Regulatory Compliance

## An Open PLC Designed to Offer Control and Recording... Easily

E+PLC is an open standards based PLC platform combined with decades of knowledge in precision PID control and tamper resistant recording, packaged in easy to use function blocks and libraries for fast implementation.

- Standard CODESYS® platform
- No learning curve - standard IEC 61131-3 programming
- Eurotherm highly respected PID control and tamper resistant recording built in

## Accurate Measurement Enables Better Process Performance

- Aids control precision for process stability
- Enables consistent repeatability

## Precision Control and Setpoint Programmer Enable Efficiency Optimization

- Reduce processing time
- Contribute to energy saving and cost reduction
- Minimize process waste

## Tamper Resistant Recording Aids Compliance to Industrial Regulations and Quality Standards

- Data recorded inside the PLC; minimizes the risk of data loss
- Backward compatible file formats for long term archiving and retrieval
- Flexible data management strategies including Batch functionality

## A PLC Designed to Offer Faster Integration

- Reduces product selection time
- Minimizes engineering time
- Reduces equipment and wiring costs
- Provides connectivity features for fast integration with other products

## Available as a Product or Fully Engineered System

- Knowledgeable engineering teams for application specific support
- Expertise in machine and process control within general and regulated industries
- Project design, installation and after sales services

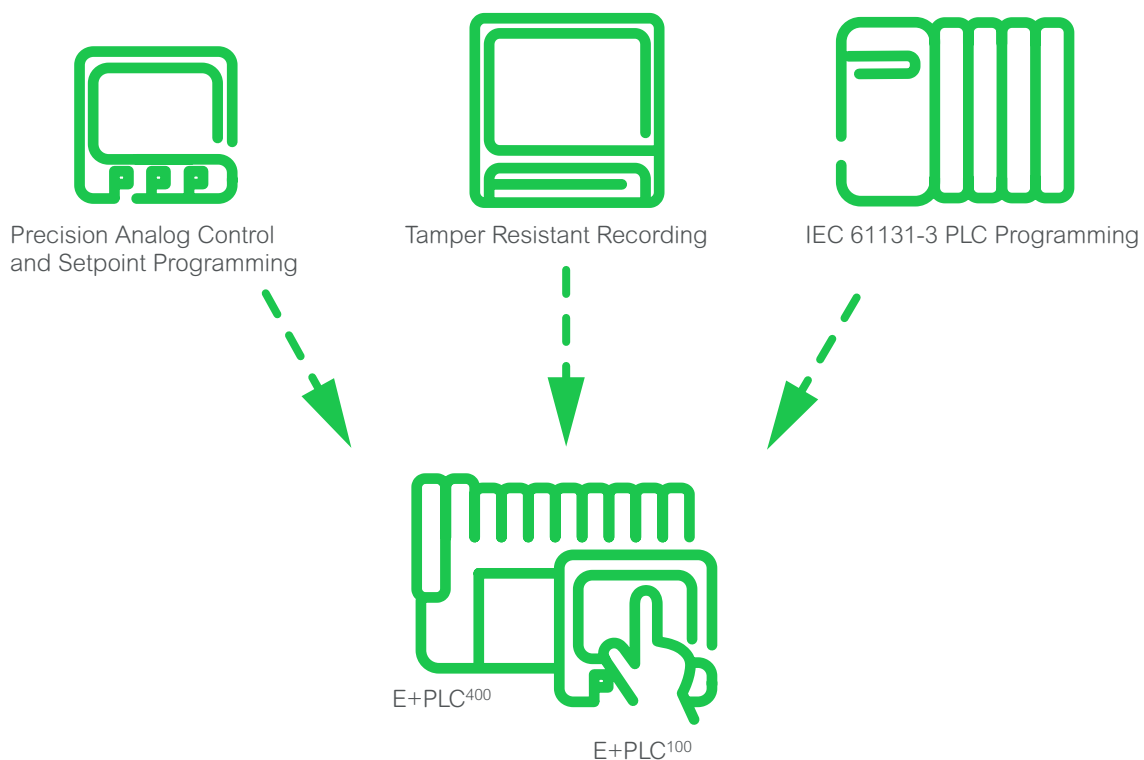

# The Right Solution for your Application

Small Machines

## E+PLC<sup>100</sup> – Single Box Solution



E+PLC<sup>100</sup>

- A compact combination PLC
- Precise control, setpoint programmer and tamper resistant recording fully integrated within a PLC application
- Minimizes engineering and commissioning costs while maximizing process performance
- Inbuilt advanced PID and setpoint programmer functions
- Continuous and batch recording
- Visualization remotely browsable from smart devices

Large Machines

## E+PLC<sup>400</sup> – Modular Platform Solution with Optional E+HMI<sup>150</sup>



E+PLC<sup>400</sup>

- A modular combination PLC with selectable base sizes to suit your application
- Precise control, setpoint programmer and tamper resistant recording fully integrated within a PLC application
- Minimizes engineering and commissioning costs while maximizing process performance
- Inbuilt advanced PID and setpoint programmer functions
- Continuous and batch recording
- Visualization remotely browsable from multiple devices
- More processing power and I/O, make it suitable for larger machines with more complex functionality
- Larger memory allows more extensive use of ladder logic and sequencing programs

Process Plants

## T2750 PAC – Plant-wide Solution with Plug in Redundancy

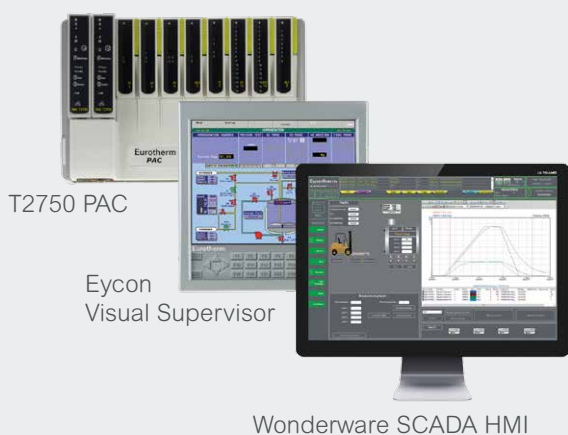

T2750 PAC

Eycon  
Visual Supervisor

Wonderware SCADA HMI

- Complete distributed control and recording environment
- Easy system redundancy
- High availability solution
- Cost effective, high end solution
  - Continuous analog, logic and sequential control
  - Suitable for ISA-S88 batch management
  - Tamper resistant recording at point of measurement



## ... Whatever its Size



Small scale single process up to 4 PID loop machine applications

E+PLC<sup>100</sup> is a cleverly designed open PLC platform with integrated control, setpoint programmer and recording in a single, compact instrument. Full PLC functionality is provided by IEC 61131-3 languages within CODESYS IDE for ease of use. For its size, it has an impressive selection of precision I/O, making it ideal for smaller applications.

- Integrated HMI with intuitive 3.5" touchscreen display
- Integrated mobile/remote visualization
- Provides four analog inputs, and up to three digital inputs, two logic outputs, three relay outputs and three DC outputs (dependent on I/O option board).
- Modbus TCP Master/Slave communications for easy integration into wider systems
- OPC DA connectivity
- Internal recording into tamper resistant files at point of measurement, for later archiving to USB media or via FTP
- Intuitive operation, easily engineered



Medium scale multi-loop, sequenced manufacturing lines

E+PLC<sup>400</sup> is a modular open PLC platform solution which uses CODESYS IEC 61131-3 integrated development environment. Integrated control, setpoint programmer and recording along with scalable base sizes make it ideal for larger machines/processes. All functionality, including visualization, is engineered through the E+PLC single programming environment, for efficient engineering.

- Versatile range of precision analog and digital I/O modules
- Connect up to two E+HMI<sup>150</sup> operator panels
- Integrated mobile/remote visualization
- Modbus TCP and Serial RTU Master/Slave communications for easy integration into wider systems
- OPC DA connectivity through a PC based OPC server
- Internal recording into tamper resistant files at point of measurement, for later archiving to USB media or via FTP

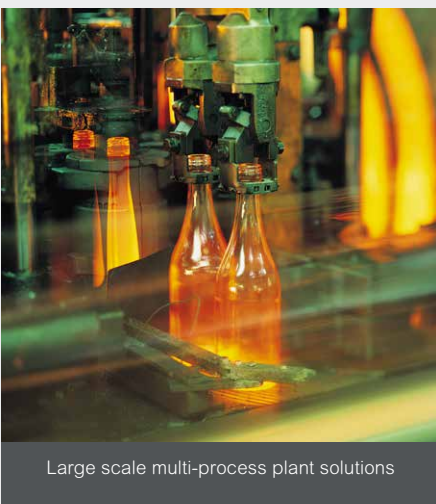

Large scale multi-process plant solutions

For larger process plants, the T2750 PAC (programmable automation controller) provides high performance control in a sophisticated, distributed solution. Modular control units and I/O form a scalable distributed control and recording environment which offers design flexibility in a high integrity solution.

- Easily integrated as part of a complete Wonderware SCADA HMI solution
- Redundancy for high availability
- DCS style functionality
- Plant-wide automation and control solution
- Modbus TCP, Modbus Serial Master/Slave and Profibus DP communications, plus OPC DA through a PC based OPC server
- Designed to aid compliance with FDA 21 CFR Part 11 regulations and GAMP guidelines

For Plantwide Distributed Control see Eurotherm T2750 PAC Brochure  
Discover more: [www.eurotherm.com/t2750pac](http://www.eurotherm.com/t2750pac)

# CODESYS Platform Features

E+PLC takes advantage of CODESYS, a leading platform which provides a proven, efficient engineering tool. Control and Visualization are built in the single integrated development environment (IDE), reducing the time and cost of implementing a system.

Engineers have the flexibility to develop sophisticated strategies and corresponding HMI functionality, with seamless integration between the two. Advanced Eurotherm algorithms can be readily selected from a library of easily applied function blocks. The resulting solution provides a standard, open platform for application development.

## Enhanced Visualization for Custom Views of the Process

For ease of use and faster setup, the fully integrated CODESYS Visualization tool offers a modular facility to create enhanced views of the plant.

- Visualization editor with built in graphical elements
- Easy creation of styles for custom look and feel
- Bespoke visualization libraries for application re-use
- Modern HMI techniques for enhanced views of simulation, operation and monitoring of the plant

## Keeping Up with the Latest Technology

The CODESYS open platform approach facilitates a knowledge sharing culture with numerous support forums

- Continuous maintenance and development of new technologies
- Developed through years of specialist industry knowledge
- Involved in committees that contribute to the international IEC 61131-3 standard

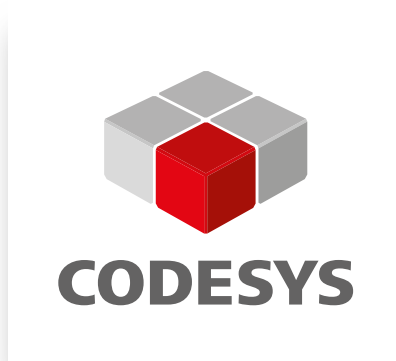

CODESYS® is a trademark of 3S-Smart Software Solutions GmbH.

[www.codesys.com](http://www.codesys.com)

## Ladder Diagram Implementation

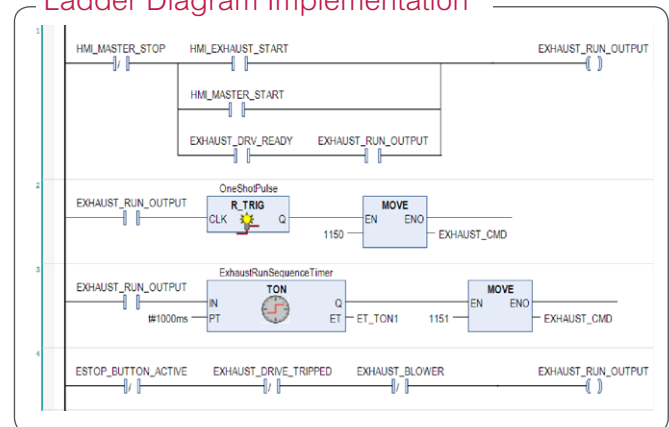

## Flexible Programming on an Open PLC Platform

### IEC 61131-3 Programming Languages Supported:

- Continuous Function Chart (CFC)
- Ladder Diagram (LD)
- Sequential Function Chart (SFC)
- Function Block Diagram (FBD)
- Structured Text (ST)
- Instruction List (IL)

### Easy Engineering, Faster Commissioning:

- Comprehensive built in libraries of function blocks
- Unique Eurotherm libraries containing function blocks such as precision PID, autotune, setpoint programming, batch recording and archiving
- Custom and 3rd party library support
- Users can define bespoke function blocks and visualization elements for simplified duplication throughout the application, or for reuse across multiple applications.
- Supports a wide range of data types from booleans to 64 bit reals, including the ability for the user to define their own data structures.

### Preservation of Intellectual Property

- Application programs are compiled in a tamper resistant format to mitigate the risk of reverse engineering.

“

*The flexibility of programming in CODESYS integrated development environment in combination with the precision control and maths functionality made E+PLC<sup>100</sup> the most convenient solution”*

OEM Engineer

## CFC Implementation with Eurotherm Function Blocks

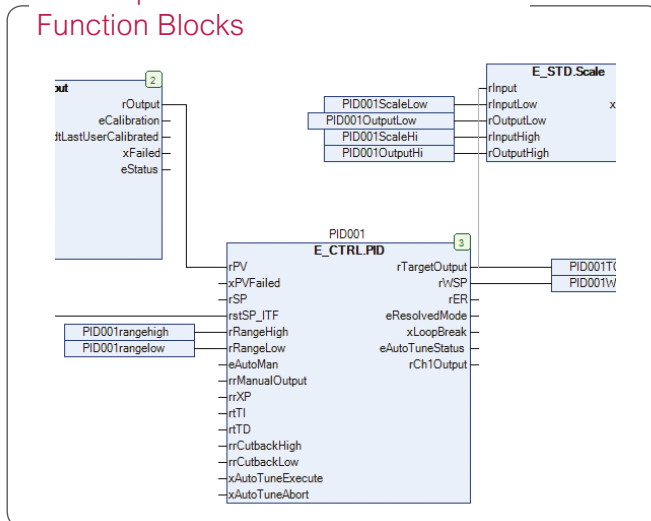

## User Management

Access rights for individual users or user groups can be conveniently managed from within the IDE. For example, a push button visualization element could be configured to change controller settings.

Login functionality, password management and user management are available at runtime via the HMI. Password controlled access helps prevent unauthorized use.

## Recipe Manager

Recipes are available for setting and watching control parameters. These can be saved, loaded and executed via visualization elements, and edited at runtime from within the CODESYS IDE. They can also be combined with the Eurotherm Batch Data Management function blocks to enable Batch processes.

## Integrated Alarm Management

Alarms can be based on input signals or other PLC variables, and their conditions displayed on the HMI for acknowledgement by the user. Alarms can be grouped if required, and events can be triggered and processed from within any of the programming languages.

Triggered alarms can be recorded within Eurotherm UHH data files for historical purposes. This can be achieved utilizing function blocks in the Eurotherm Data Recording library.

## Multiple Controllers within a Single Project

CODESYS single engineering and visualization environment allows simple reuse of base code, enabling multiple E+PLC controllers to be combined into a single CODESYS project, or the screens of one project to be displayed on several different HMI devices.

## Program Portability

CODESYS elements can be imported and exported between projects. The capability to import or export XML files in PLCopen format is also supported, allowing transfer of code to and from any PLC that supports this open standard.

## Debugging Support

The CODESYS debugging tool provides a number of useful features for validating applications, as well as real time access to running programs from the engineering environment:

- Display of application data at runtime from within E+PLC
- Reading, writing, and forced setting of variable values, from within editors or watch lists
- Setting of conditional and absolute breakpoints, and subsequent code execution in single steps or complete cycles
- Display of application data from a simulation 'SoftPLC' enables debugging without hardware



“

*I've been waiting for this combined functionality for a long time. There are many out of date PLC based systems in the field that require precision PID control. We can now replace these with E+PLC<sup>400</sup> combination PLCs.”*

System Integrator Engineer

# Accurate Measurement in a PLC

To control precisely you need to measure accurately. Unlike traditional PLCs, E+PLC analog input and output modules offer similar accuracy specifications to our highly respected Eurotherm discrete controller and PAC ranges.

Designed to withstand the challenging conditions of heavy industrial environments, accurate I/O helps to minimize control oscillations and enable tighter control to setpoints within tolerance. The result is high stability repeatable control that aids process optimization and regulatory compliance.

- Measurements accurate to 0.1% of span
- High rejection to industrial electrical noise
- Fast acting cold junction temperature compensation for thermocouples
- Accurate linearization for industry standard thermocouples, resistance thermometers and other sensors
- Accuracy that meets the measurement requirements of Heat Treatment standards AMS2750 and CQI-9

“

*Eurotherm group companies are our preferred supplier of discrete control and recording products but in the past we combined these with third party PLCs.*

*We carried out controlled testing to compare the PID control performance of the E+PLC<sup>400</sup> product with the discrete controllers. The results were identical, far out performing the standard PID control typically available in traditional PLCs. The E+PLC<sup>400</sup> combination PLC is now our preferred solution.”*

System Integration Engineer

## Eurotherm Standard Library Function Blocks Include:

- ✓ Scaling, linearization, error handling, filtering calibration and override features for mA, RTD, TC and Voltage inputs
- ✓ Signal conditioning - temperature and electrical signal conversions, offsets, threshold limit overrides, scaling, filtering

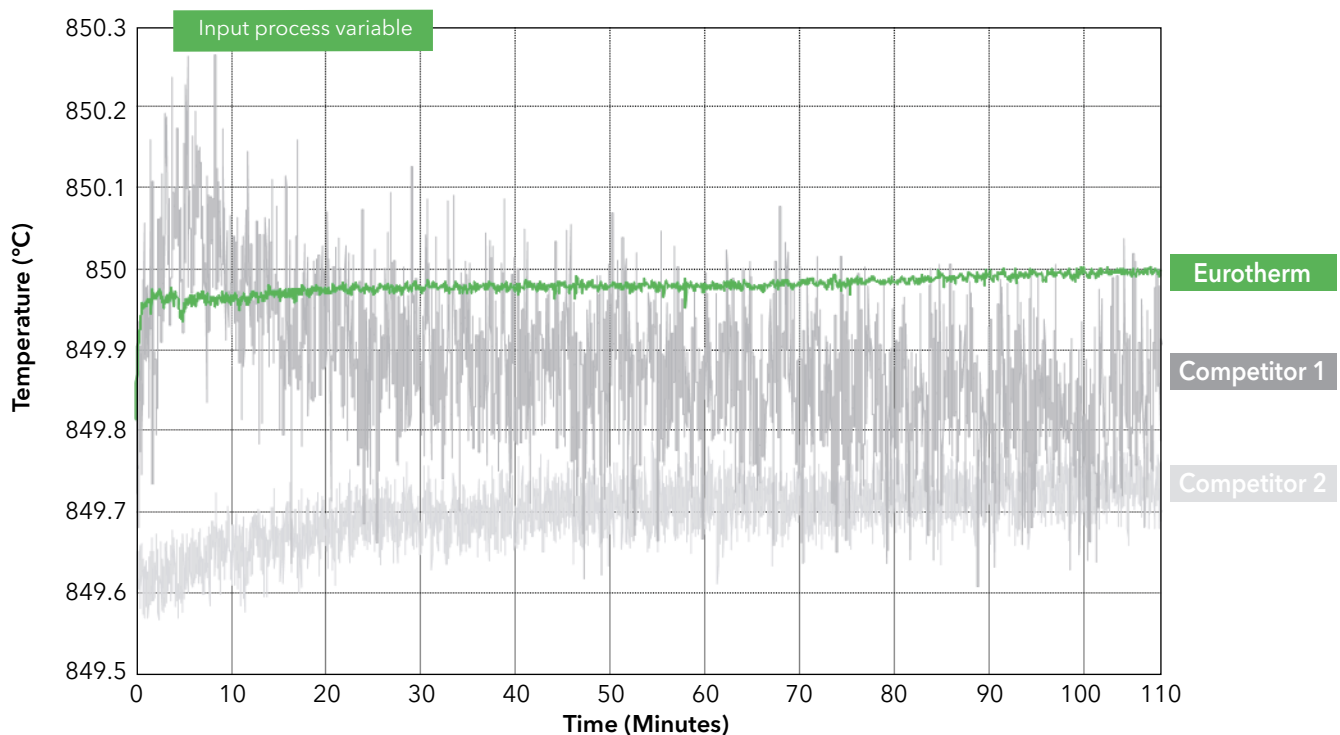

Accurate, low noise inputs contribute to control precision and repeatability of the process. Particularly important in advanced manufacturing processes and regulated industries.



# Auto-tuning PID Control in a PLC

Unique Eurotherm auto-tuning PID algorithms are contained within E+PLC in the form of easy to use function blocks. Designed to provide similar precision control performance to Eurotherm discrete controller and PAC products they offer improved process performance and higher quality results in an all in one solution.

## Improved Process Performance Helps to:

- Optimize processing time
- Minimize energy usage
- Produce high quality products that meet their regulatory requirements
- Maximize overall equipment effectiveness (OEE)

## Precision Control for Specialist Industries

Cutback and overshoot suppression features enable process variables to ramp to required setpoints quickly, within tight tolerances, improving the stability and repeatability of processes.

An effective autotune algorithm minimizes commissioning and loop setup time.

Eurotherm libraries also contain specialized function blocks that simplify control in industries such as Heat Treatment and Life Sciences.

## Advanced Control with Reduced Engineering

Eurotherm pre-engineered control function blocks and visualization elements are readily available from Eurotherm libraries within CODESYS integrated development environment. Users need to simply parameterize the blocks and implement them as many times as required for an application.

Comprehensive maths string processing (ASCII & Unicode) functionality is also available from within CODESYS libraries.

Operating over temperature results in:

- Wasted energy
- Over-heated product
- Possible scrap

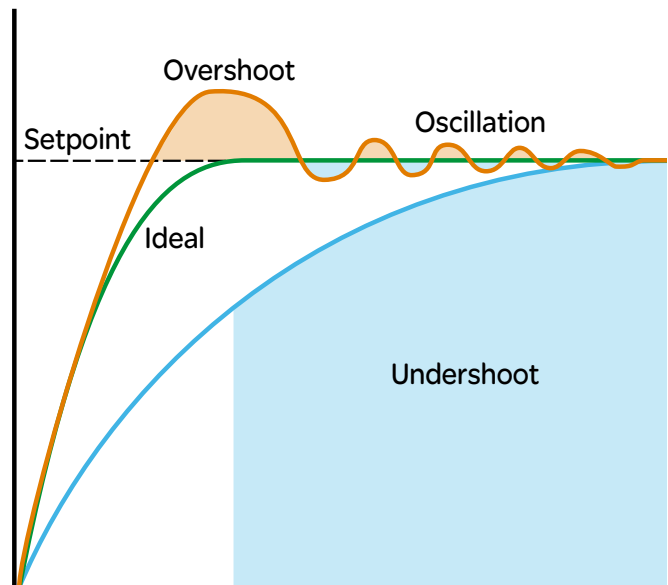

Operating under temperature results in:

- Wasted time
- Wasted energy
- Slower throughput
- Possible non-conformance and re-processing

## Eurotherm Control Library Function Blocks Include:

- ✓ Single, dual channel and full sets of On/Off, PID and VPU (valve positioning) control
- ✓ Autotune - tune sets and variables for control function blocks
- ✓ Gain Scheduling - six extra PID sets which can be tuned to reach different setpoints
- ✓ Setpoint Generator – for simple control of multiple parameters
- ✓ PID Visualization Faceplate - shows process variable and setpoint values alongside output, represented as a 0-100% horizontal bar graph
- ✓ I/O includes time proportioned output (TPO)

# Easy Setpoint Programming in a PLC

## Reduces Programming Time and Helps to Optimize the Process

An easy to use flexible setpoint programmer is included in E+PLC providing straightforward configuration that greatly reduces engineering time compared to traditional PLCs. The programmer closely integrates with Eurotherm PID control to help maintain the setpoint within tight tolerances. Programmed segments can be configured in conjunction with other events, and the different programs can be selected using a recipe function.

## Efficient Engineering

- Simple spreadsheet style data entry with drop-down lists
- Programmers can be designed for specific applications
- OEM, System Integrator and end customer intellectual property can be embedded in the programmer
- Unlimited segments, setpoints and events (dependent on available application memory only)

## Improved Process Efficiency Reduces Costs and Produces High Quality Results

- Precise performance against required thermal profile with minimal overshoot during ramps
- Rapid control response
- Holdback function offers 'Guaranteed Thermal Soak' time
- Multiple setpoint programs to suit a range of production requirements
- Running programs can be edited
- Inbuilt recovery routines in case of electrical power supply interruption

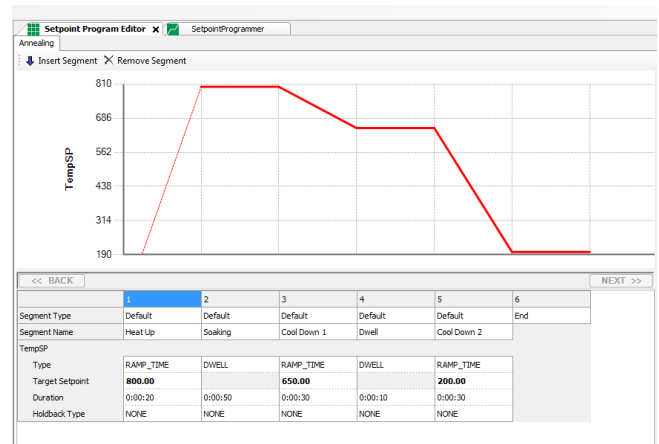

Visual representation of setpoint changes

## Eurotherm Setpoint Programmer Library Function Blocks Include:

- ✓ Programming of multiple channels in segments plus loading and execution of programs
- ✓ Visualization - graphical setpoint program editor element, for loading editing and running programs

	1	2	3
Segment Type	HeatUp	Soak	Cooling
Segment Name			
Temperature (degC)			
Target Setpoint	500		
Duration		2:00:00	
Ramp Period	0:00:00		
Pressure	0.000e+000	0.000e+000	0.000e+000
InBandThermocouple	Control T/C	Control T/C	
DeviationBand (degC)	0.0	Control T/C	
CoolingType		Lowest Load T/C Highest Load T/C Load T/C 1 Load T/C 2 Load T/C 3	Atmosphere

## Setpoint Program Editor

- Segment Type is customizable for the use of process relevant terminology
- Segment Name is customizable for any duty on the HMI
- Irrelevant parameters are blanked out to simplify setup
- Names can be customized in a drop-down list to suit the application

# A PLC with Integrated Visualization

## Creating Views on to the Process

E+PLC provides embedded visualization which enables dynamic diagnostics of application programs together with concurrent development of the final process. Contained within a single programming environment, process displays are easily created for use where and when you need them. The same process displays are also available in HTML5 format for use on other HMIs.

- Efficient engineering in a single programming environment with automatic tag browsing
- Dynamic program diagnostics
- Extensive, configurable graphics libraries
- Integrated local HMI on E+PLC<sup>100</sup>
- Connect up to two E+HMI<sup>150</sup> operator panels to E+PLC<sup>400</sup>
- HTML5 web server for remote access from mobile devices such as tablets and Smart phones



## E+HMI<sup>150</sup> Operator Panels - Integrated with the Process

E+HMI<sup>150</sup> touch screen operator interface panels are available in 7" and 13" models for local or remote monitoring and operation of the process. Custom libraries allow OEMs, system integrators and end customers to create branded applications utilizing their own IP.

- Powerful graphics capability
- Easy creation of operator friendly interfaces from built in visualization elements and libraries
- Custom libraries for OEM branding
- TFT color touchscreen display
- Slim design with mounting depth less than 50mm
- Two Ethernet ports with integrated switch

## Visualization Elements in Eurotherm Libraries Include:

- ✓ Setpoint Program Editor and Profiler
- ✓ PID Faceplate
- ✓ Runtime Display Data with Historical Trend
- ✓ Steel Specification Faceplate, Carbon Diffusion Profiler and Carbon Diffusion Faceplate, for heat treatment applications
- ✓ Vacuum Faceplate
- ✓ Keyboard Library with keypads and data entry dialogs

“

*The visualization libraries in CODESYS IDE gave us the customization we needed to create our own screens and promote our brand.”*

OEM engineer

# Tamper Resistant Recording in a PLC

## Compliance with Regulatory and Quality Standards

Regulated industries typically require data recording formats that are resistant to tampering, and available for quality control and auditing at a later date. The E+PLC range utilizes several data management strategies that aid data integrity and file security.

## Smart Efficient Data Management

Data files are stored in Eurotherm proprietary tamper resistant file format (.UHH), a better alternative compared to commonly used editable .CSV files. Process data such as operator logins, messages, alarms and other events can also be recorded for traceability.

- Integrated recording functionality easily configurable in the CODESYS IDE
- Data is recorded within a dedicated high availability file system on the E+PLC, reducing dependence upon communications to a Historian on a remote server
- Data archiving is automatically restarted when communications are available
- Tamper resistant backward compatible file format
- 'Highly Reliable File System' (HRFS) helps to prevent possible loss or corruption of data due to power interruptions.
- Traceability of what happened in the process and when

## Intuitive channel configuration

**Zone1 Control\_TC**

Format Used When Displaying Point Value:

Digital Inactive String:

Digital Active String:

Units Displayed With Point Value:

Colour Used When Trending Point:

Minor Scale Divisions:

Major Scale Divisions:

Scale Type:

Decimal Places:

Zone Low:

Zone High:

Span Low:

Span High:

## Eurotherm Data Recording Library Function Blocks Include:

- ✓ Recording of operator and auditor messages, operator login/logout, group alarm notification
- ✓ Memory capacity, duration and status information
- ✓ Setup of archiving via FTP and USB
- ✓ Visualization element - display of runtime and historical data, configurable via an intuitive interface

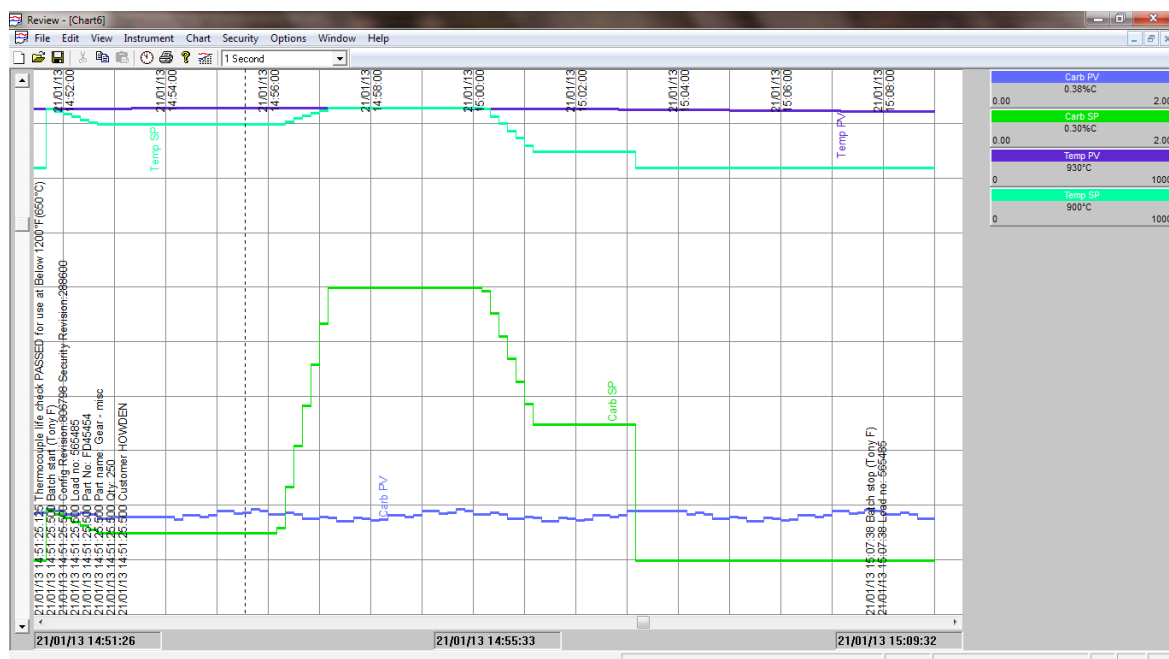

Recorded data can be retrieved from history files at any time using Eurotherm Review, for analysis or reporting purposes.



# Batch Data Management in a PLC

Searching for batch data in paper records can be time consuming. With E+PLC, process and metadata associated with a batch can be captured using easily configurable function blocks in the Eurotherm library. Just search by batch code in Eurotherm Review Software for quick retrieval of the data.



- Efficient handling of batch data with intuitive search facility
- Simple traceability of operator actions in the batch
- Batch recording automatically recovers after power interruptions
- Compatible with ISA S88 batch control standard

## Eurotherm Batch Manager Function Blocks include:

- ✓ Recording of batch start/stop time and operator names
- ✓ Custom metadata such as product ID's, customer information and unique batch identifiers

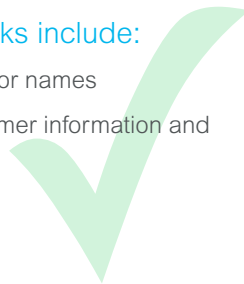

The batch function can be called from the data recording management library by command buttons or sequences, to record relevant messages into tamper resistant history files. For example, the status of equipment can be logged to provide end-of-batch information, such as the energy used a by a connected EPack power controller.



Batch Start and Stop records can be triggered from any language (FBD, LD, ST etc.) in any work flow and can easily be added to the tamper resistant recorded history files. The application designer can configure all recorded parameters such as batch field names, to provide an application specific solution.

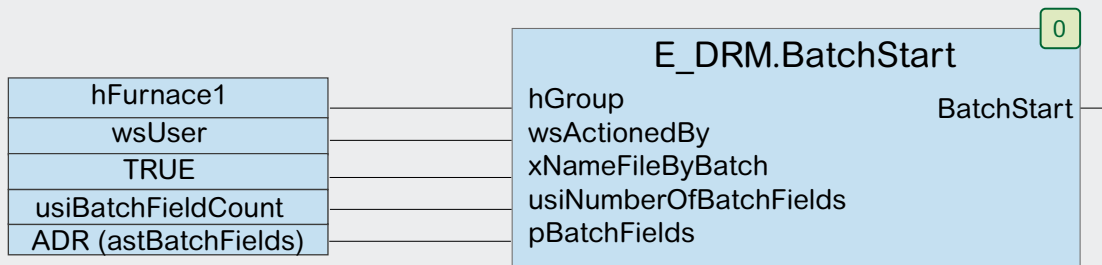

“

*The impact of having recording built into the E+PLC range is valuable to us because it offers our customer a more economical data acquisition solution.”*

System Integration Engineer

“

*We really like the flexibility of the visualization. We can overlay the trend traces to compare the process to the programmed temperature profile, and record it all to review at a later date if we need to.”*

System Integration Engineer

# Open Connectivity to Wider Systems and Industry 4.0 Technologies

## Flexible Communications Designed for Easy Integration

User data can be exchanged to/from external devices using XML or CSV format. E+PLC products support Modbus communication to enable connection to other instruments and controllers.

- Easy connection of Eurotherm products including controllers, recorders, drives and power controllers
- Modbus library function blocks for quick set up of Eurotherm EPower™ and EPack™ power controllers, Mini8 Loop Controllers and 3200i indicators

## Straightforward integration into wider DCS/SCADA solutions

In addition to Modbus, OPC Server for Windows PC included in CODESYS allows exchange of data from within E+PLC and 3<sup>rd</sup> party devices, for example from HMIs or process data logging programs.

- Includes OPC server, a server configurator, and a logger for debugging
- Simple symbol based configuration of data to be exported

## Ethernet Based Protocols Enable Integration into IIoT/Industry 4.0 technologies and 3<sup>rd</sup> party devices

- Modbus TCP/IP master/slave communications
- Serial Modbus RTU master/slave for connection to legacy equipment
- Transfer of process data records via FTP to multiple specified servers
- Inbuilt configurable Webserver allows remote view and control of key parameters through mobile devices
- Open TCP/UDP communications accessible for programmers within applications in the IDE
- Integrates into Eurotherm Online Services Platform (EOS) for simplified calibration certification

### Integration Architecture for E+PLC<sup>100</sup> — External connections

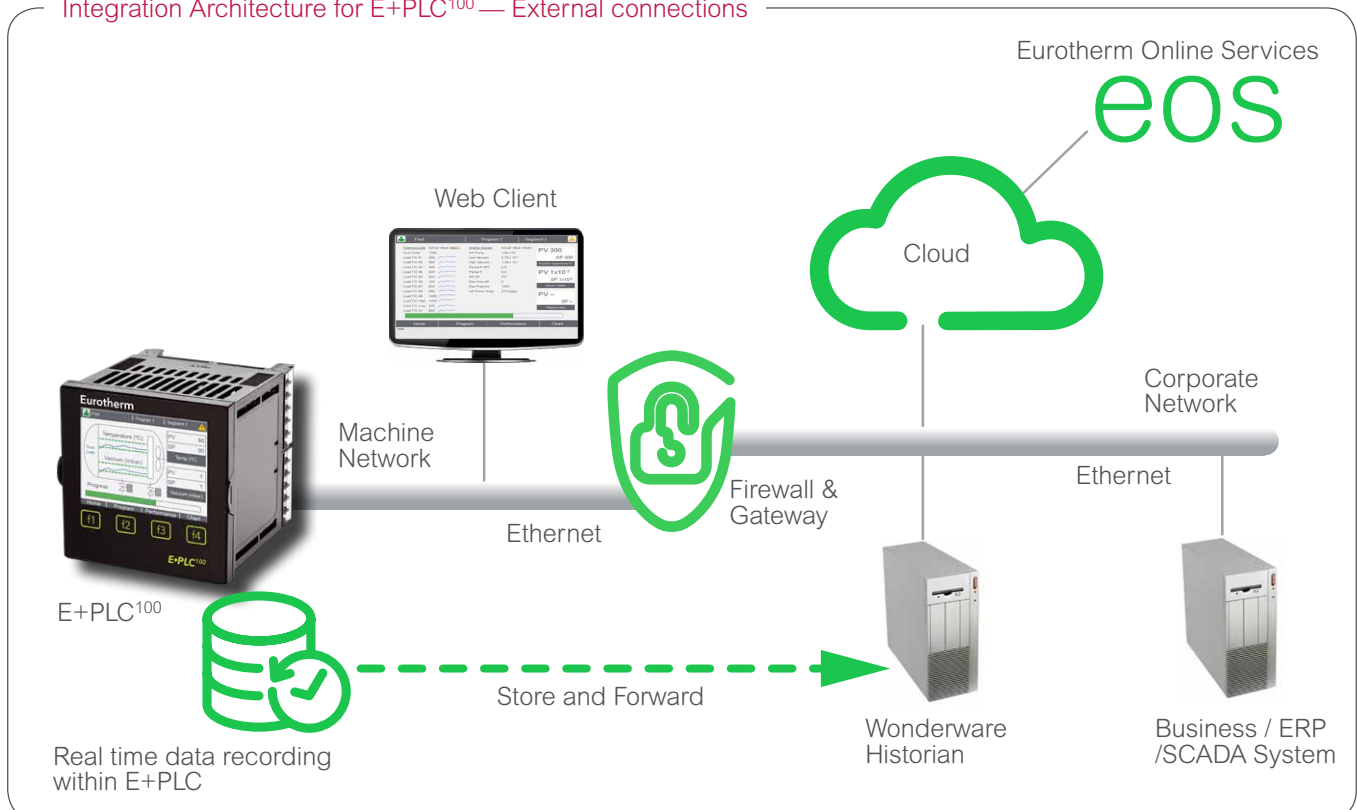

## Multiple E+PLC<sup>400</sup> Architecture with E+HMI<sup>150</sup>, Web Client and Configuration Platform

Configuration Platform



Web Client

E+HMI<sup>150</sup>

Application host



Monitoring



Monitoring

- Multiple E+PLC<sup>400</sup> devices can be used for applications where additional precision analog control is required
- Architectures also available based upon Wonderware System Platform

For more information on architectures - contact your local sales representative

[eurotherm.com/worldwide](http://eurotherm.com/worldwide)

“

*“A customer wanted to increase efficiency by creating batches automatically when orders were entered into their ERP (Enterprise Resource Planning) system. The Eurotherm solution automatically entered data into XML format, where it was ready for processing. The E+PLC regularly copied newly entered data from the enterprise system to its own Batch queue using FTP over Ethernet communications. Automating the data entry process met our customers efficiency requirement by reducing data entry time. Additionally, human interactions and bar code scanners were no longer required, which reduced operator related errors and equipment costs.”*

System Integrator Engineer

## EOS Advisor - for Paper Free Management of Your Plant's Regulatory Status

The calibration of E+PLC can be easily maintained using EOS Advisor an efficient Eurotherm Online Service for managing calibration and accreditation information. Calibration status of your plant equipment can be checked and scheduled using a simple, intuitive web interface. From calibration certificates for individual products, to calibration reports covering individual plant systems and machines, information can quickly be retrieved for audit by authorized users. EOS Advisor offers an efficient alternative to traditional paper based calibration systems, helping to maximize plant availability and workflow across multiple sites, and aiding compliance with regulatory standards such as Nadcap, AMS2750E and CQI-9.



# A Combined Solution for Machine Control

## Easily Integrated Power Control

Eurotherm EPack™ and EPower™ ranges provide advanced strategies that help to minimize energy usage in high energy processes. Modbus TCP communications allow connectivity to the E+PLC network, while in-built EPower and EPack address registers selected from the E+PLC Modbus library allow quick and easy integration with the E+PLC platform.

### Eurotherm Modbus Library Function Blocks Include:

- ✓ EPack and EPower Energy Consumption
- ✓ EPower Channel - for single, two-leg 3-phase, and 3-phase control strategies
- ✓ EPower PLM - for Predictive Load Management
- ✓ EPower Alarm Management

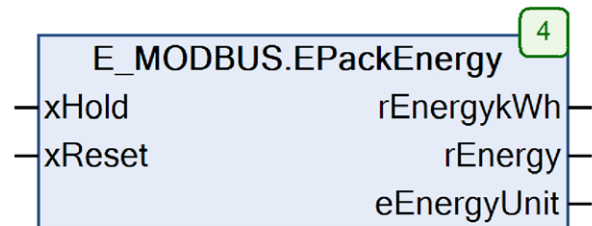

### Eurotherm Power Controllers

- Suitable for 1, 2, or 3 phase systems
- QuickStart setup, and advanced configuration using Graphical Wiring Editor
- Advanced firing modes help improve power factor for optimum energy efficiency
- Energy usage data available such as true power, apparent power and power factor for reporting KPIs



EPack

### EPack Compact Power Controllers

- Compact design ideal for smaller cabinets
- Highly adaptable via flexible software upgrades
- DIN rail and bulkhead mounting
- For applications up to 125A, 500V



EPower

### EPower Advanced Power Controllers

- Predictive Load Management and load shedding technologies reduce the risk of peak energy fines, by helping to keep the plant within its agreed energy tariff.
- Automatic transformer load tap changing strategy for smooth power control with reduced maintenance.
- For applications up to 630A, 690V

## Energy Efficient Motor Drives



Eurotherm offers an extensive range of AC drives, soft starters and DC drives to suit a wide range of applications. Easy configuration, installation, and operation are featured throughout the ranges along with flexible programming and high accuracy performance.



Drives



# Selection Guide

E+PLC and T2750 PAC				
Features		E+PLC <sup>100</sup>	E+PLC <sup>400</sup>	T2750 PAC
Autotuning PID		✓	✓	✓
Setpoint programmer		✓	✓	✓
Tamper Resistant Recording		✓	✓	✓
Archiving Strategy		✓	✓	✓
Batch Management		✓	✓	—
Processor Redundancy		—	—	✓
Peer-to-Peer Communication		✓	✓	✓
Programming Platform		CODESYS (open)	CODESYS (open)	LIN (proprietary)
Programming Languages		IEC61131-3 compliant CFC, FBD, IL, LD, SFC, ST	IEC61131-3 compliant CFC, FBD, IL, LD, SFC, ST	Based on IEC61131-3, FBD, SFC, ST
Product I/O Format		Fixed	Up to 16 x modules	Up to 16 x modules
Available I/O Dependant on build variant		Fixed: I/O AI (4), DI (2) RLY (2) Optional: DI/O (1), DO (1), RLY (1) or AO (3)	Modules: AI2, AI3, AI4, AI8 AO2, DI6, DI16, DO16, RLY8, ZI	Modules: AI2, AI3, AI4, AI8 AO2, DI4, DI6, DI8, DI16, DO4, DO8, DO16, RLY4, RLY8, FI2, ZI
I/O Expansion Method		Modbus	Modbus	Modbus
Communications Protocols		FTP, Modbus TCP (Master/Slave)	FTP, Modbus TCP (Master/Slave) Modbus Serial RTU (Master/Slave)	FTP, Modbus TCP (Master/Slave) Modbus Serial RTU (Master/Slave) Profibus DP (Master)
Suitable for AMS2750E Process		✓	✓	✓
Recording Duration (approx) Based on 4 chs at intervals at:	1s 10s 20s 60s	13 days 130 days 260 days 2 years	50 days 1 year 2.5 years 8 years	15 days 150 days 300 days 2.5 years
Panel HMI (Protocol)		Built in (OPC-DA)	E+HMI <sup>150</sup> (OPC-DA)	EYCON (LIN-OPC)
Web Visualization		✓	✓	—
Mounting		Panel	DIN	DIN

## What our Customers Say

“

*“PC based control systems typically limited system life to 5-10 years due to software upgrade compatibility issues - a big price hit for our customers.*

*Using an off-the-shelf product like E+PLC<sup>400</sup> will enable us to maintain them for longer, which better fits the life of the rest of the equipment”.*

OEM Engineer  
Environmental Chamber Application

“

*“Our customer was trying to save space in the factory so they really benefitted from the smaller cabinet design, thanks to the combined functionality of E+PLC”*

System Integrator Sales Engineer  
Heat Treatment Application

“

*“Locking out operators with password access so they can only change parameters if we allow it is a useful feature for us”*

Production Engineer  
Petrochemical Industry

# Engineering Services for a Lifetime of Support

The innovative technology provided in the E+PLC platform is supported throughout its lifecycle by highly professional teams of engineers who understand the challenges faced in modern industry. We will help you every step of the way, from selecting the right product for your application, through professional project management and engineering services, to comprehensive global technical service and support.

Working with Eurotherm, you will be able to access the decades of knowledge and experience we have in process control, recording and automation. Our experienced, professional engineers can help you get the most from your process by assisting with programming, commissioning and helping to keep operations optimized throughout their lifetime. Our service teams will help you to keep your control well tuned, data appropriately archived, sensors correctly calibrated and systems working efficiently.

- Comprehensive, highly professional global service network, including project delivery, calibration, accreditation and training services
- Deep understanding of control, recording and industrial applications
- Experienced in solving complex control problems
- Customizable service level agreements for cost effective support and peace of mind
- Supported by a long standing team of research and development engineers and leading industry domain experts



“

*“The support we received from Eurotherm application engineers enabled us to re-engineer the system in a faster time frame”.*

System Integrator Control Engineer

# Decades of Application Knowledge in a PLC

E+PLC contains decades of experience and understanding of industrial processes, how to control them well and meet regulatory requirements. Most traditional PLCs have been developed from a sequential control platform. The E+PLC range is different. It is based on a deep understanding of analog control and data recording, and how these are applied across many industries. In combination with sequential control in CODESYS open platform it offers a 'best of both worlds' solution for machine control applications.

## Performance Without Compromise

- A single, integrated PLC solution with inbuilt advanced control, data management and visualization
- Developed from a deep understanding of precise, analog PID control and the applications in which it is required
- Designed to improve process performance, reduce energy usage and increase profitability
- Rich and versatile functionality to meet the demands of modern advanced processes

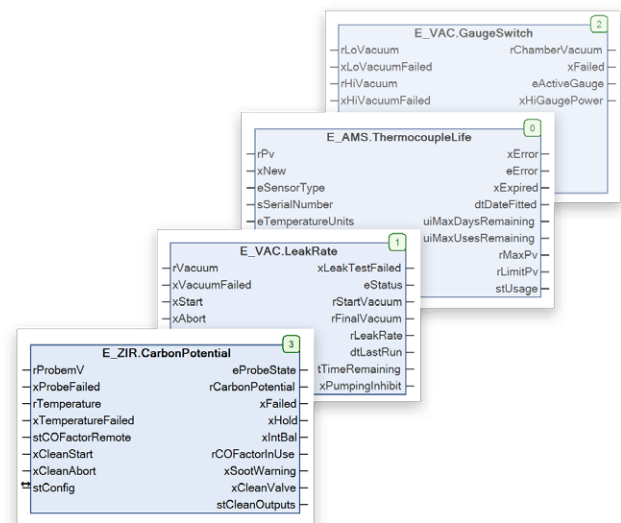

# Specialized Functionality for Heat Treatment and Materials Processing

E+PLC range contains algorithms specifically designed for Heat Treatment applications. Advanced control and data management provided by E+PLC satisfy the required levels of accuracy and data integrity for this regulated industry, while reducing engineering and operational costs.

## Heat Treatment Function Blocks Included in E+PLC

- ✓ Zirconia
- ✓ 3GASIR
- ✓ Carbon Diffusion (online carburizing)
- ✓ Holdback function for 'Guaranteed Soak'
- ✓ Thermocouple Life
- ✓ Vacuum Leak Rate - for implementing a leak test
- ✓ Vacuum Gauge Switch
- ✓ Vacuum Pump-down Timer
- ✓ Vacuum Input
- ✓ Vacuum Leak Rate
- ✓ Visualization elements including: Steel Specification Faceplate, Carbon Diffusion Profiler and Carbon Diffusion Faceplate and Vacuum Faceplate

E+PLC is suitable for use in Nadcap applications in all furnace classes A-E, as defined in section 3 of the AMS2750E standard. For more information, see [www.eurotherm.com/certificates](http://www.eurotherm.com/certificates)

## Flexible Machine Control Ideal For:

Automotive | Aerospace | Advanced Materials Processing  
 Semiconductor | Glass | Fine Chemicals | Plastics  
 Life Science | Healthcare | Food & Beverage | Water & Waste Water



Industrial Furnaces • Ovens • Autoclaves • Climatic Chambers • Annealers • Dryers • Reactors  
 Sterilizers • Incubators • Boilers • Steam Generators • Disinfection Processes  
 Industrial Distillation • Extruders • Blow Molders • Injection Molders • Melt Pressure Control  
 Batch processing • Pilot Plants • Specialist Machines and Test Equipment

See how Eurotherm customers have used E+PLC:

[eurotherm.com/eplc-case-studies](http://eurotherm.com/eplc-case-studies)

Life Is On

**Eurotherm**<sup>®</sup>

by **Schneider** Electric

Contact your local sales representative for a demo  
[eurotherm.co.uk/eplc](http://eurotherm.co.uk/eplc)

Contact us

**Eurotherm Limited**  
Faraday Close, Durrington  
Worthing, West Sussex, BN13 3PL  
Phone: + 44 (0)1903 268500  
[www.eurotherm.co.uk](http://www.eurotherm.co.uk)



Document Number HA032111 Issue 4 © 2017 Schneider Electric. Schneider Electric, Life Is On, Eurotherm, EurothermSuite, eCAT, EFit, EPack, EPower, Eycon, Eyris, Chessell, Mini8, nanodac, optivis, piccolo, and versadac are trademarks of Schneider Electric SE, its subsidiaries and affiliated companies. All other trademarks are the property of their respective owners. CODESYS® is a trademark of 3S-Smart Software Solutions GmbH.